

## Manifold Assembling Instructions

EQO *air* - EQO *h2o* - EQO *gas* - EQO *vac* - EQO *airHP* - EQO *oil* - EQO *nitro*

### 1. Needed Tools and Materials

#### 1.1. Manifold Fixing Tools

- 1.2. Drilling machine, spirit level, marker, masonry bit (If it is to be fixed on a wall), rubber or plastic mallet
- 1.3. Self-tapping screws (with cross slot head) of 5.5 maximum size, complete with wall-plugs (not less than 4 + 4 pieces, drill insert for cross slot screws).

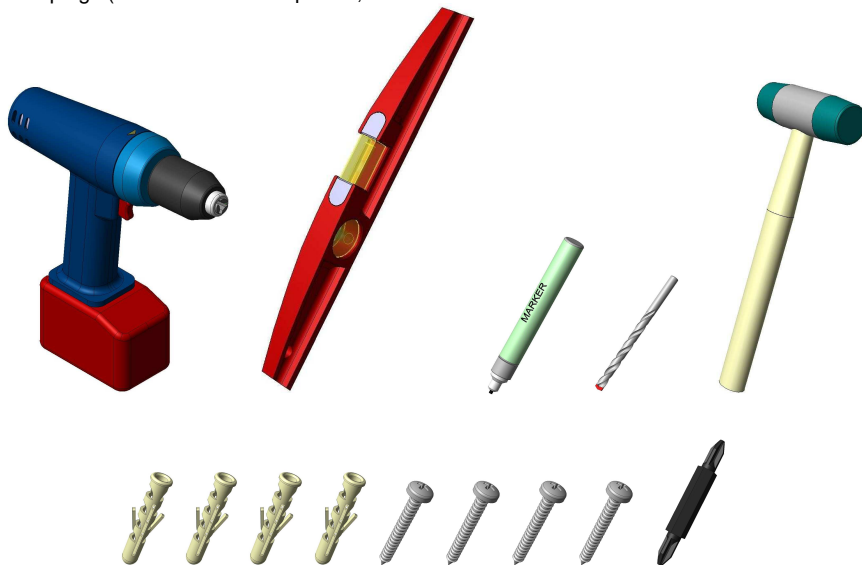

### 2. Manifold components

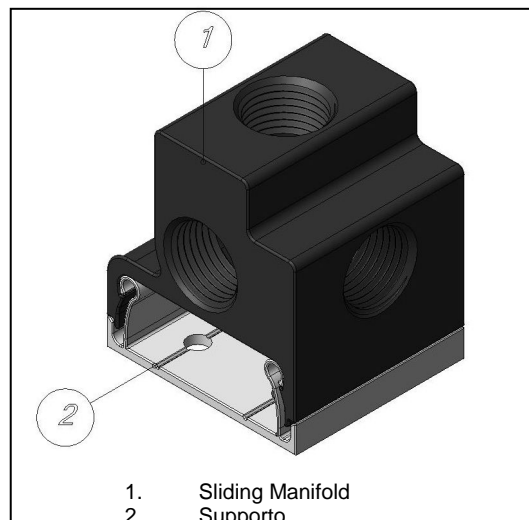

7 ways

5 ways

4 ways



### 3. Some Assembly Examples and Solutions. The holder can be supplied in bars 1 m. long, which allows modular solutions (d).

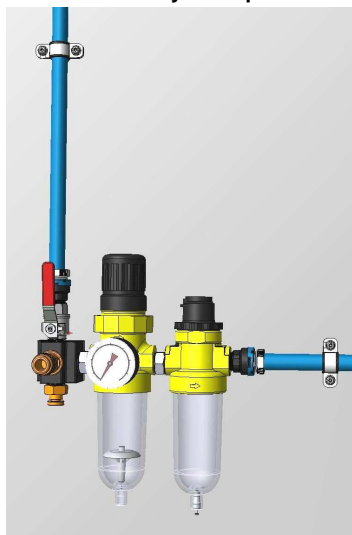

a

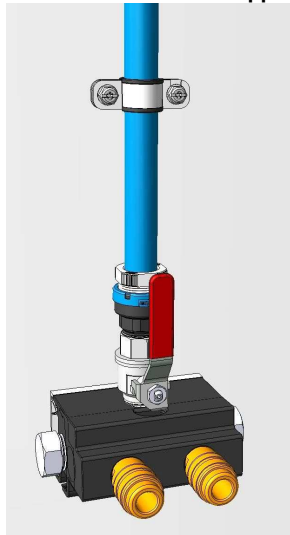

b

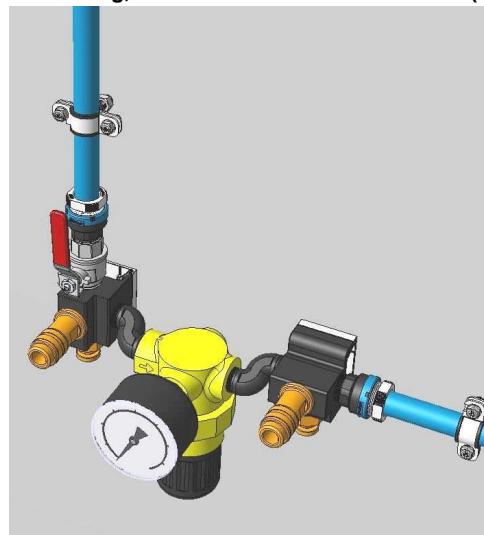

c



d





e

## Manifold Assembling Instructions

EQO air - EQO h2o - EQO gas - EQO vac - EQO airHP - EQO oil - EQO nitro

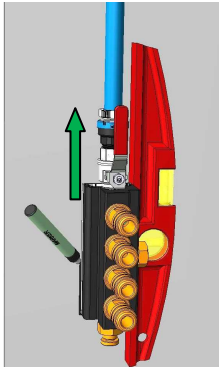
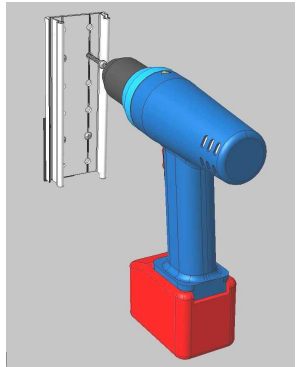
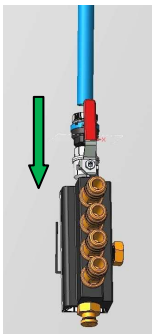
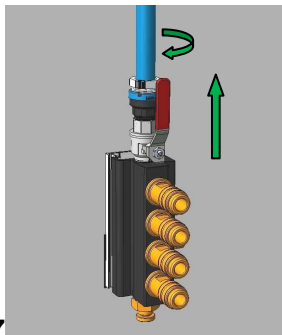
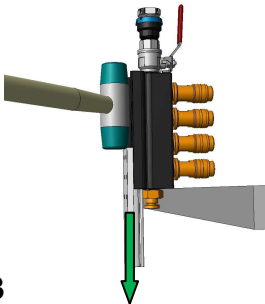
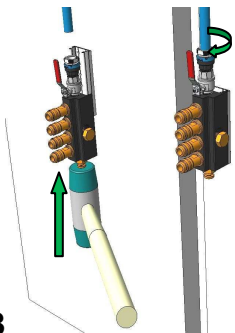
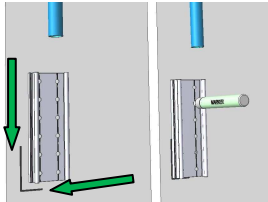
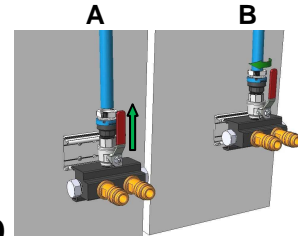
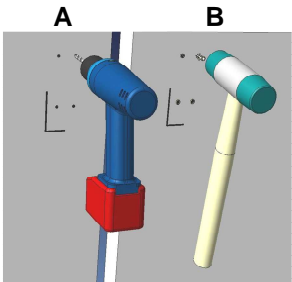
### 4. Assembly

<p>4.1 Assemble all the fittings + any valves and/or treatment group, connected to the manifold, to the outlet pipe (usually the drop pipe), leaving the inlet fitting nut completely loose. Trace the positioning keeping the elements assembled and carefully check all alignments by using a spirit level.</p>		<p>4.6 Fix the holder to the wall and carry out the final fixing according to the following different methods.</p>	
<p>4.2 Completely detach the assembly from the branch pipe</p>		<p>4.7 Vertical assembly 1 : completely insert inlet fitting into pipe , tighten the nut and connect it as shown in figure 10.</p>	
<p>4.3 Completely slip the support off the manifold by forcing it axially. To avoid any hand injury it is advisable to put the manifold on a plane and use a rubber or plastic ends mallet.</p>		<p>4.8 Vertical assembly 2 : insert manifold partially into the holder, as shown in figure 10. Then assemble it to the pipe, getting it sliding axially with the help of a soft ends mallet, if needed. Tighten the inlet fitting nut.</p>	
<p>4.4 Place the holder on the previously drawn sign again and mark the position of the holes.</p>		<p>4.9 Horizontal assembly 3 : completely assemble the inlet fitting to the pipe. Tighten the nut and carry out the connection as shown in figure 11</p>	
<p>4.5 Carry out the holes (A) and introduce the wall-plugs (B)</p>		<p>4.10 Revolving connection; it is advisable following conditions 7 and 8.</p>  <p><b>Click!</b></p>	<p>4.11 Level connection; following condition 9.</p>  <p><b>Click!</b></p>